

APEX Oil Transfer Pump

311305E
EN

For pumping non-flammable fluids, including motor oils, hydraulic fluid, and antifreeze only. Do not use to pump water.

Model 260100, 5.8 gpm (22.0 lpm), 65 psi (.45 MPa, 4.5 bar) 12 VDC
Model 260101, 4.25 gpm (16.1 lpm), 65 psi (.45 MPa, 4.5 bar) 115 VAC
Model 260102, 8.0 gpm (30.3 lpm), 30 psi (.21 MPa, 2.1 bar) 115 VAC
Model 260104, 4.25 gpm (16.1 lpm), 65 psi (.45 MPa, 4.5 bar) 230 VAC



Important Safety Instructions





Read all warnings and instructions in this manual. Save these instructions.







PROVEN QUALITY. LEADING TECHNOLOGY.

Warnings

The following general warnings are for the setup, use, grounding, maintenance, and repair of this equipment. Additional, more specific warnings may be found throughout the body of this manual where applicable. *Symbols appearing in the body of the manual refer to these general warnings. When these symbols appear throughout the manual, refer back to these pages for a description of the specific hazard.*

 WARNING	
	<p>FIRE AND EXPLOSION HAZARD</p> <p>When flammable fluids are present in the work area, such as gasoline and windshield wiper fluid, be aware that flammable fumes can ignite or explode. To help prevent fire and explosion:</p> <ul style="list-style-type: none"> • Use equipment only in well ventilated area. • Eliminate all ignition sources, such as cigarettes and portable electric lamps. • Keep work area free of debris, including rags and spilled or open containers of solvent and gasoline. • Do not plug or unplug power cords or turn lights on or off when flammable fumes are present. • Ground all equipment in the work area. • Use only grounded hoses. • If there is static sparking or you feel a shock, stop operation immediately. Do not use equipment until you identify and correct the problem. • Keep a fire extinguisher in the work area.
	<p>ELECTRIC SHOCK HAZARD</p> <p>Improper grounding, setup, or usage of the system can cause electric shock.</p> <ul style="list-style-type: none"> • Turn off and disconnect power at main switch before disconnecting any cables and before servicing equipment. • Connect only to grounded power source. • All electrical wiring must be done by a qualified electrician and comply with all local codes and regulations.
	<p>PERSONAL PROTECTIVE EQUIPMENT</p> <p>You must wear appropriate protective equipment when operating, servicing, or when in the operating area of the equipment to help protect you from serious injury, including eye injury, inhalation of toxic fumes, burns, and hearing loss. This equipment includes but is not limited to:</p> <ul style="list-style-type: none"> • Protective eyewear • Clothing and respirator as recommended by the fluid and solvent manufacturer • Gloves • Hearing protection

 WARNING	
	<p>PRESSURIZED EQUIPMENT HAZARD</p> <p>Fluid from the gun/dispense valve, leaks, or ruptured components can splash in the eyes or on skin and cause serious injury.</p> <ul style="list-style-type: none"> • Follow Pressure Relief Procedure in this manual, when you stop dispensing and before cleaning, checking, or servicing equipment. • Tighten all fluid connections before operating the equipment. • Check hoses, tubes, and couplings daily. Replace worn or damaged parts immediately.
	<p>EQUIPMENT MISUSE HAZARD</p> <p>Misuse can cause death or serious injury.</p> <ul style="list-style-type: none"> • Do not operate the unit when fatigued or under the influence of drugs or alcohol. • Do not exceed the maximum working pressure or temperature rating of the lowest rated system component. See Technical Data in all equipment manuals. • Use fluids and solvents that are compatible with equipment wetted parts. See Technical Data in all equipment manuals. Read fluid and solvent manufacturer's warnings. For complete information about your material, request MSDS forms from distributor or retailer. • Check equipment daily. Repair or replace worn or damaged parts immediately with genuine Graco replacement parts only. • Do not alter or modify equipment. • Use equipment only for its intended purpose. Call your Graco distributor for information. • Route hoses and cables away from traffic areas, sharp edges, moving parts, and hot surfaces. • Do not kink or over bend hoses or use hoses to pull equipment. • Keep children and animals away from work area. • Comply with all applicable safety regulations.
	<p>BURN HAZARD</p> <p>Equipment surfaces and fluid that's heated can become very hot during operation. To avoid severe burns, do not touch hot fluid or equipment. Wait until equipment/fluid has cooled completely.</p>

Installation



The oil transfer pumps are positive displacement pumps. The motors are drip proof rated at 3/4 hp. The motors have sealed bearings and require minimal maintenance. All models come with hose, nozzle, 34 in. (864 mm) suction tube assembly, and bung adapter.

When unpacking check for shipping damage. Report any shipping damage to delivering carrier immediately. See **Parts**, page 8.

Mounting Pump on Barrel or Tank

1. Install bung adapter (14) in barrel bung and tighten.
2. Assemble suction tube sections (18) by applying PVC cement (21) to the inside diameter of the PVC couplers (19, 20). Make sure PVC cement is applied to the complete inside diameter and slide the pipe sections into the coupler with a twisting motion.

 For tanks deeper than 36 in. (914 mm) you will need a standard 1 in. (25 mm) pipe with 1 in. npt threads on one end. If pumping used oil, install suction screen assembly, Part No. 260306, to filter large contaminants.

For tanks less than 36 in. (914 mm) deep, cut the suction tube to leave about 2 in. (21 mm) of clearance between the bottom of the suction tube and the bottom of the tank.

3. Apply pipe sealant (not the supplied PVC cement) to the threaded end of the suction tube and then screw the tube into the pump inlet port. Make sure tube is tight.
4. Insert suction tube already attached to the pump through bung adapter and lower the pump onto the bung adapter. Position the pump as desired and tighten swivel nut to the bung adapter (14).

Mounting Hose and Nozzle

1. Before connecting hose to the pump, pour 8 oz (0.24 l) of oil in the pump outlet port so that the pump does not run dry during initial start-up.
2. Apply pipe sealant to male threads of the elbow (12) and screw the elbow into the outlet port.
3. Apply pipe sealant to one end of hose assembly (17) and screw hose end into the elbow (12).
4. Apply pipe sealant to other end of hose assembly and screw the nozzle (15, 16) onto the hose.

Electrical Installation 115 VAC and 230 VAC



The 115 VAC models (260101 and 260102) come wired with a short power cord and a grounded electrical plug. Power to the unit must be 115 VAC single phase. If an extension cord is required, it should be a 3-wire cord with a ground. Use a 20 amp circuit to supply power to the pump.

The 230 VAC model (260104) is not shipped with a power cord and plug. You must purchase and install an appropriate power cord and plug that meets your local electrical codes.

Electrical Installation 12 VDC

The 12 VDC model (260100) is not shipped with a power cord since the installation will determine the length of the power cord.

1. Verify the on/off switch is in the off position.
2. Remove the wiring junction box cover by removing the four screws.
3. Use 10 AWG wire to connect the red (+) and black (-) wires to the 12 VDC supply.
4. Reattach the wiring junction box cover with the four screws.

Operation

CAUTION
Do not operate pump dry. Do not run pump for more than 5 minutes with nozzle closed.

 See **Parts**, page 8 for items referenced in parentheses, i.e., (17).

1. On/Off switch is located on the motor (9). Move switch to ON position.
2. Insert nozzle into container or fill tube and open nozzle to dispense fluid.
3. Close nozzle to stop flow. The pump has an internal bypass valve that will bypass the fluid internally with nozzle closed.
4. Immediately after dispensing, turn switch to OFF position.

Pressure Relief Procedure

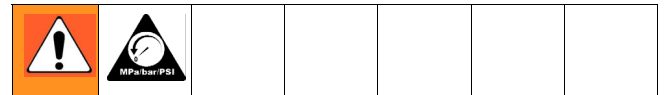

1. Verify pump switch is OFF.
2. Open nozzle to relieve any residual pressure.
3. To prevent damage to the pump, use inlet suction screen (260306) when pumping used oils.

Troubleshooting

Problem	Cause	Solution
Motor runs but pump will not prime.	Motor rotation wrong. (260100 only)	Check wiring instructions for possible problems.
	Dirt under pressure relief valve.	Remove pressure relief valve and inspect, clean, or replace if damaged.
	Worn or damaged gears.	Remove cover and inspect gears. Replace if worn or damaged.
	Oil level low.	Refill tank.
	Cover seal (5) damaged.	Replace if worn or damaged.
	Inlet suction screen clogged (used oil).	Remove and clean or replace.
	Air leak in suction tube.	Inspect all joints in suction tube, make sure all threaded joints have sealant applied.
	Air lock in system.	This may occur if filter or meter or automatic shut-off nozzle is used. If this occurs, fill pump and meter with fluid through top of pump.
Motor does not run at proper speed.	Check electric connections. Ensure supply voltage is at proper level.	
Oil leaking in motor mount.	Faulty or damaged motor shaft seal.	Replace shaft seal (4).
	Operating pump extended time with nozzle closed.	Do not exceed 5 minutes of operation with nozzle closed.
	Motor shaft worn.	Replace motor if shaft has groove worn in seal area.

Problem	Cause	Solution
Unit pumps but output flow is low.	Clogged inlet suction screen (used oil).	Clean or replace.
	Air leak in suction tube.	Check to make sure all joints in suction tube are sealed.
	Suction tube too close to tank bottom.	Suction tube must have a 2 in. (51 mm) minimum clearance.
	Tank empty.	Refill tank.
	Tank not vented.	Tank must be vented to atmosphere.
	Worn or damaged gears.	Remove cover and inspect gears. Replace if worn or damaged.
	Damaged motor.	Replace motor.
	Clogged suction tube, hose, or nozzle.	Inspect and clean.
Motor stalls when nozzle is closed.	Bypass relief valve is stuck.	Inspect relief valve, making sure ball is free. Replace if damaged.
	Low supply voltage.	Check supply voltage.
	Gears damaged and binding.	Inspect gears. Gears should turn freely. Replace if damaged.
	Faulty motor.	Replace motor.
Motor overheating.	Gears binding.	Check to make sure gears turn freely on shaft.
	Operating pump extended time with nozzle closed.	Do not exceed 5 minutes of operation with nozzle closed.
	Clogged inlet suction screen.	Clean or replace.
	Clogged suction tube, hose, or nozzle.	Inspect and clean if required.
	Operating pump more than 30 minutes continuous duty.	Limit operation to 30 minutes per hour.
Switch will not turn pump on.	Blown fuse or circuit breaker.	Check electrical supply.
	Electrical problem.	Check that supply voltage is proper and getting to pump.
	Defective switch.	Check and replace motor (9) if defective.
	Damaged or defective motor.	Check motor, replace if damaged or defective.

Parts

Model 260100, 12 VDC
Model 260101, 115 VAC

Model 260102, 115 VAC
Model 260104, 230 VAC

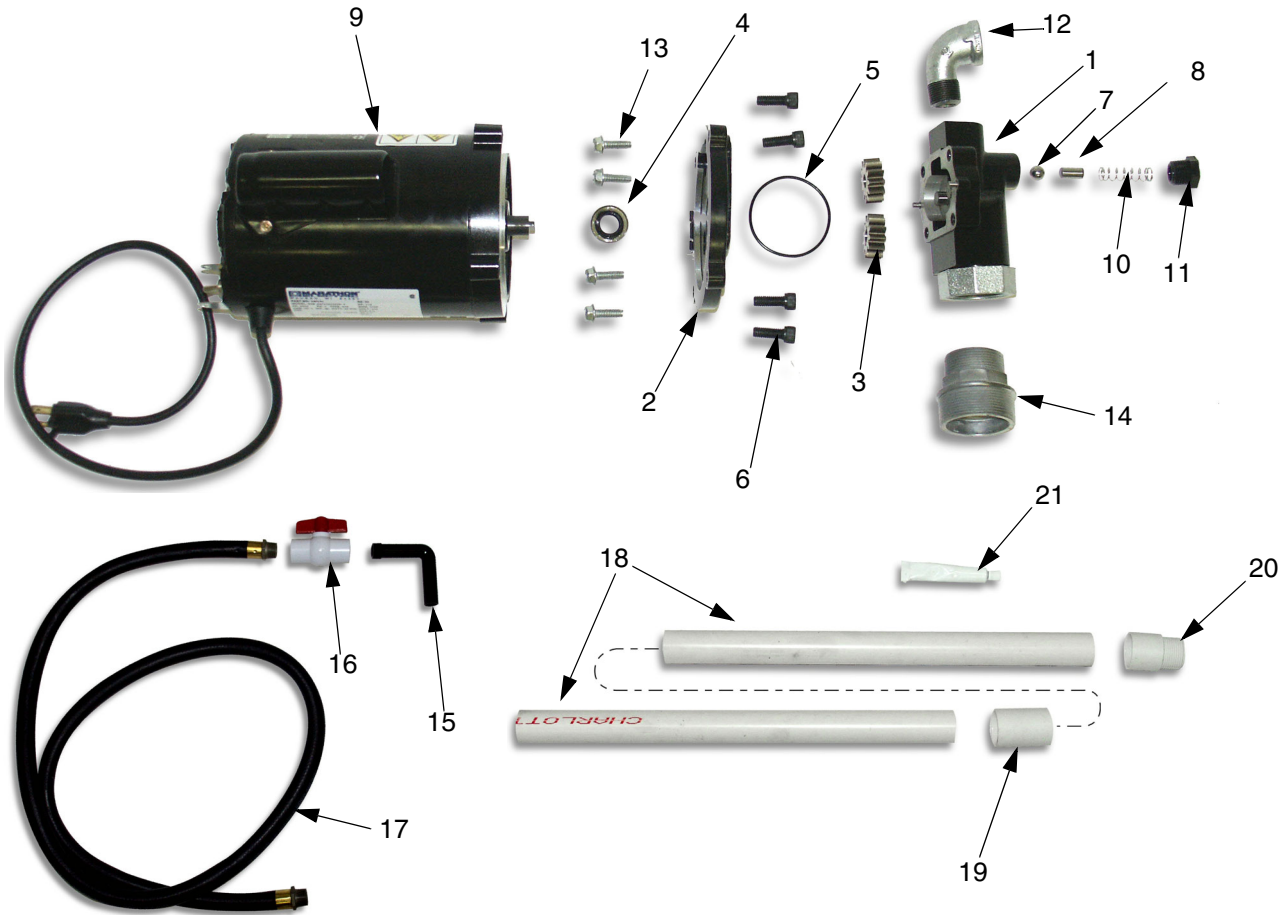

Ref. No.	Description	Qty.	Ref. No.	Description	Qty.
1	PUMP BODY	1	12	ELBOW, street, 3/4 npt	1
2	ADAPTER, pump motor	1	13	SCREW, cap, 5/16-18	4
3	GEAR, pump	2	14	ADAPTER, bung	1
4	SEAL, shaft	1	15	NOZZLE	1
5	O-RING	1	16	VALVE, ball	1
6	SCREW, 3/8-16 socket head, cap	4	17	HOSE, petroleum	1
7	BALL, relief valve	1	18	PIPE, PVC	2
8	PIN, dowel, steel, 3/8 x 3/4	1	19	COUPLER, PVC, female	1
9a	MOTOR, 115 VAC	1	20	ADAPTER, PVC male	1
9b	MOTOR, 115 VAC, 8 gpm	1	21	CEMENT, PVC	1
9c	MOTOR, 12 VDC	1	22▲	LABEL, warning (not shown) Part no. 15G901	1
9d	MOTOR, 230 VAC (This model does not include power cord and plug. Must be purchased separately.)	1			
10a	SPRING, relief valve 115 VAC, 12 VDC	1			
10b	SPRING, relief valve 115 VAC, 8 gpm	1			
11	PLUG, 1/2 npt	1			

▲ Replacement Danger and Warning labels, tags, and cards are available at no cost.

Kits

Kit Number	Description	Includes Items
260040	ELBOW, street, 3/4npt	12
260061	ADAPTER, bung	14
260125	KIT, valve	15, 16
260216	HOSE, 8 ft	17
260292	KIT, packing	4, 5
260293	KIT, gear	3, 4, 5
260297	KIT, pressure relief (models 260100, 260101, and 260104)	7, 10a, 11
260298	KIT, pressure relief (model 260102)	7, 10b, 11
260300	KIT, suction pipe	18, 19, 20, 21
260495	KIT, fluid, 115 VAC, 230 VAC, 12 VDC (models 260100, 260101, and 260104)	1, 2, 3, 4, 5, 7, 8, 10a, 11, 13
260496	KIT, fluid, 115 VAC, 8 gpm (model 260102)	1, 2, 3, 4, 5, 7, 8, 10b, 11, 13
260497	KIT, motor, 115 VAC	9a
260498	KIT, motor, 115 VAC, 8 gpm	9b
260500	KIT, motor, 12 VDC	9c
260499	KIT, motor, 230 VAC	9d

Technical Data

Maximum Working Pressure	65 psi (0.45 MPa, 4.5 bar)
Automatic Relief Setting	Models 260100, 260101, 260104: 65 psi (0.45 MPa, 4.5 bar)
	Model 260102: 30 psi (0.21 MPa, 2.1 bar)
Output Flow	Model 260100: 5.8 gpm (22.0 lpm) Model 260101: 4.25 gpm (16.15 lpm) Model 260102*: 8.0 gpm (30.3 lpm) Model 260104: 4.25 gpm (16.15 lpm)
Inlet Size	1 in. npt
Outlet Size	3/4 in. npt
Weight	Model 260100: 34 lb (15.3 kg) Models 260101, 260102, 260104: 25 lb (11.25 kg)
Dimensions	See page 11
Voltage/current	Model 260100: 12 VDC, 35 amps Models 260101, 260102: 115 VAC, 60 Hz, 9.2 amps Model 260104: 230 VAC, 50/60 Hz, 4 amps
Power Cord	Model 260101, 260102 only: 30 in. (762 mm)
Hose size	8 ft (2.4 m), 3/4 in. (19 mm) ID
Suction tube	34 in. (864 mm)
Wetted parts	carbon steel with zinc plating, stainless steel, galvanized steel, aluminum, nitrile, rubber, PVC, PVC cement

**Model 260102 is intended for use with fluid viscosities of 1000 centistokes (5000 ssu) or less. For fluids with viscosities greater than 1000 centistokes use pump model 260101.*

Dimensions

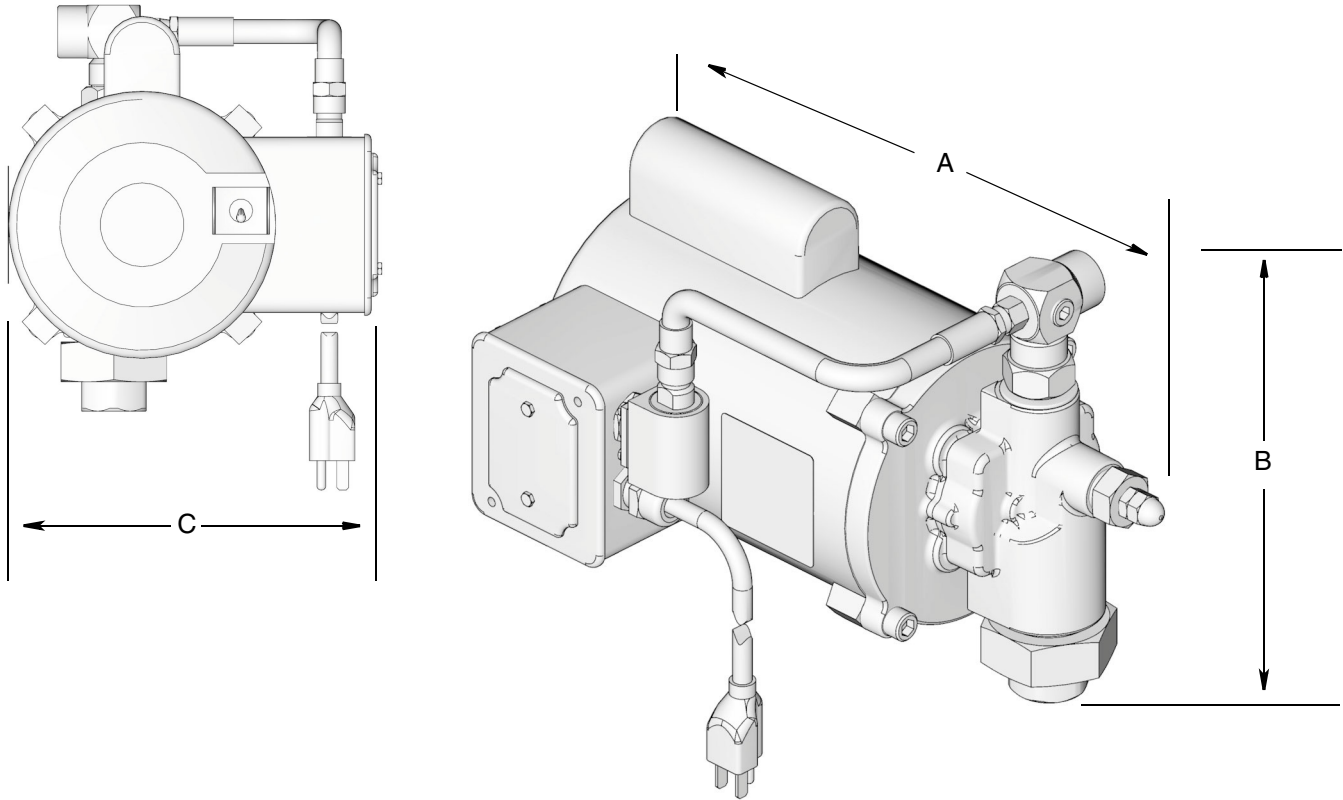

Models	Length (A)		Height (B)		Width (C)	
	Inches	mm	Inches	mm	Inches	mm
260100	13.25	336.5	8	203.2	7.75	196.8
260101	12.5	317.5	8	203.2	6.75	171.4
260102	12.75	323.8	8	203.2	6.25	158.7
260104	13.75	349.2	8	203.2	6.5	165.1

Performance Chart

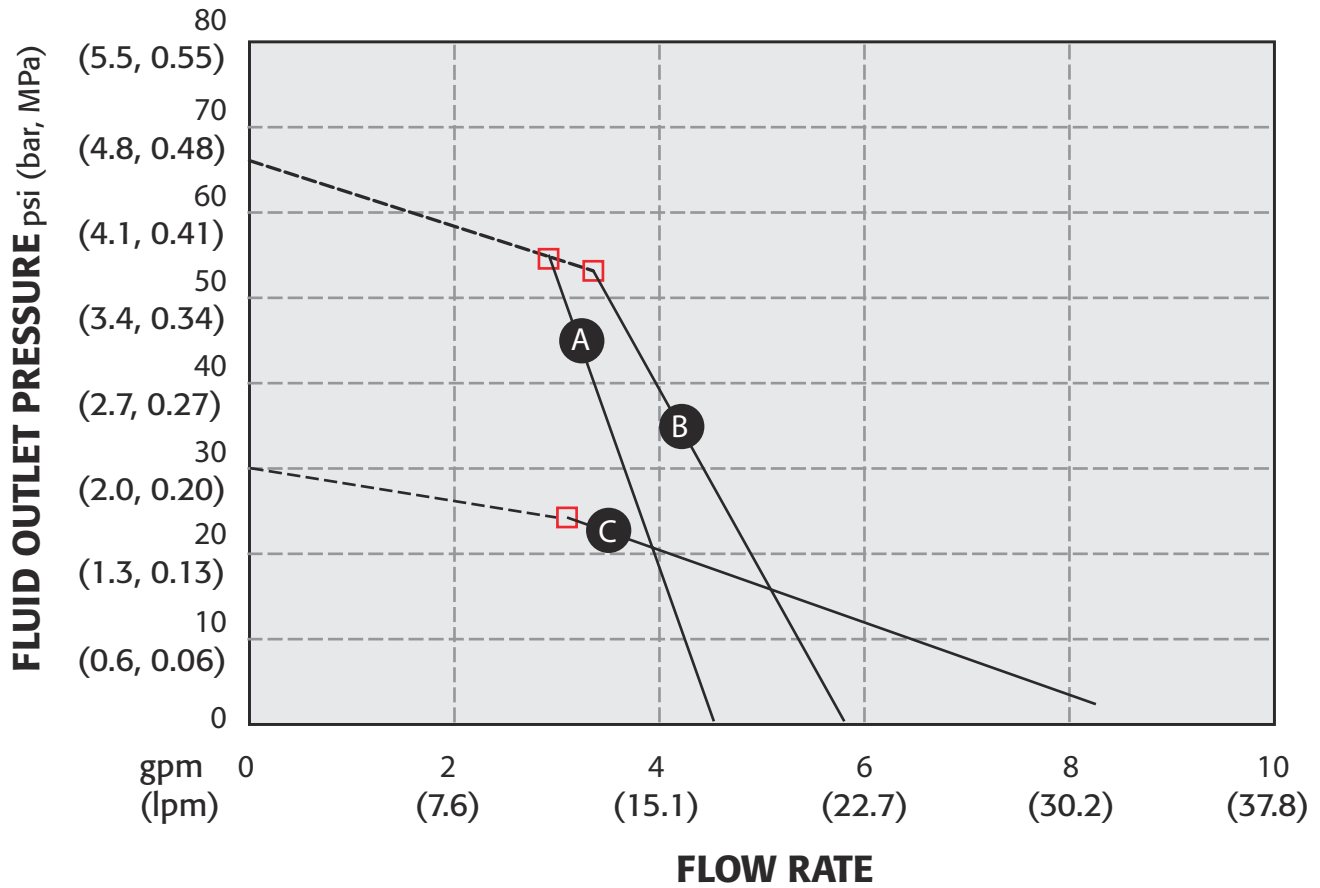

PART NUMBERS LEGEND	
(A) = 260101, 260104	Pressure relief opens <input type="checkbox"/>
(B) = 260100	
(C) = 260102	

Notes



A series of 21 horizontal lines spaced evenly down the page, providing a ruled area for writing notes.

Graco Standard Warranty

Graco warrants all equipment referenced in this document which is manufactured by Graco and bearing its name to be free from defects in material and workmanship on the date of sale to the original purchaser for use. With the exception of any special, extended, or limited warranty published by Graco, Graco will, for a period of twelve months from the date of sale, repair or replace any part of the equipment determined by Graco to be defective. This warranty applies only when the equipment is installed, operated and maintained in accordance with Graco's written recommendations.

This warranty does not cover, and Graco shall not be liable for general wear and tear, or any malfunction, damage or wear caused by faulty installation, misapplication, abrasion, corrosion, inadequate or improper maintenance, negligence, accident, tampering, or substitution of non-Graco component parts. Nor shall Graco be liable for malfunction, damage or wear caused by the incompatibility of Graco equipment with structures, accessories, equipment or materials not supplied by Graco, or the improper design, manufacture, installation, operation or maintenance of structures, accessories, equipment or materials not supplied by Graco.

This warranty is conditioned upon the prepaid return of the equipment claimed to be defective to an authorized Graco distributor for verification of the claimed defect. If the claimed defect is verified, Graco will repair or replace free of charge any defective parts. The equipment will be returned to the original purchaser transportation prepaid. If inspection of the equipment does not disclose any defect in material or workmanship, repairs will be made at a reasonable charge, which charges may include the costs of parts, labor, and transportation.

THIS WARRANTY IS EXCLUSIVE, AND IS IN LIEU OF ANY OTHER WARRANTIES, EXPRESS OR IMPLIED, INCLUDING BUT NOT LIMITED TO WARRANTY OF MERCHANTABILITY OR WARRANTY OF FITNESS FOR A PARTICULAR PURPOSE.

Graco's sole obligation and buyer's sole remedy for any breach of warranty shall be as set forth above. The buyer agrees that no other remedy (including, but not limited to, incidental or consequential damages for lost profits, lost sales, injury to person or property, or any other incidental or consequential loss) shall be available. Any action for breach of warranty must be brought within two (2) years of the date of sale.

GRACO MAKES NO WARRANTY, AND DISCLAIMS ALL IMPLIED WARRANTIES OF MERCHANTABILITY AND FITNESS FOR A PARTICULAR PURPOSE, IN CONNECTION WITH ACCESSORIES, EQUIPMENT, MATERIALS OR COMPONENTS SOLD BUT NOT MANUFACTURED BY GRACO. These items sold, but not manufactured by Graco (such as electric motors, switches, hose, etc.), are subject to the warranty, if any, of their manufacturer. Graco will provide purchaser with reasonable assistance in making any claim for breach of these warranties.

In no event will Graco be liable for indirect, incidental, special or consequential damages resulting from Graco supplying equipment hereunder, or the furnishing, performance, or use of any products or other goods sold hereto, whether due to a breach of contract, breach of warranty, the negligence of Graco, or otherwise.

FOR GRACO CANADA CUSTOMERS

The Parties acknowledge that they have required that the present document, as well as all documents, notices and legal proceedings entered into, given or instituted pursuant hereto or relating directly or indirectly hereto, be drawn up in English. Les parties reconnaissent avoir convenu que la rédaction du présente document sera en Anglais, ainsi que tous documents, avis et procédures judiciaires exécutés, donnés ou intentés, à la suite de ou en rapport, directement ou indirectement, avec les procédures concernées.

Graco Information

TO PLACE AN ORDER, contact your Graco distributor or call to identify the nearest distributor.

Phone: 612-623-6928 **or Toll Free:** 1-800-533-9655, **Fax:** 612-378-3590

All written and visual data contained in this document reflects the latest product information available at the time of publication. Graco reserves the right to make changes at any time without notice.

For patent information, see www.graco.com/patents.

Original instructions. This manual contains English. MM 311305

Graco Headquarters: Minneapolis
International Offices: Belgium, China, Japan, Korea

GRACO INC. AND SUBSIDIARIES • P.O. BOX 1441 • MINNEAPOLIS MN 55440-1441 • USA

Copyright 2005, Graco Inc. All Graco manufacturing locations are registered to ISO 9001.

www.graco.com
Revised August 2012